

## Understanding Students' Process for Solving Engineering Problems Using Eye Gaze Data

**Youyi Bi, Purdue University**

Youyi Bi is a doctoral student in the School of Mechanical Engineering, Purdue University. He obtained his B.S. in Mechanical Engineering and M.S. in Aerospace Manufacturing Engineering both from Beihang University, China. His research interest include decision-making and optimization in mechanical design, ergonomics and computer graphics.

**Tahira N Reid, Purdue University, West Lafayette**

# Understanding Students' Process for Solving Engineering Problems Using Eye Gaze Data

## Abstract

It is well known that engineering is considered one of the more demanding fields of study to embark on. In mechanical engineering, courses such as thermodynamics, statics, mechanics of materials and others are perceived as challenging by students. Several factors impact students' ability to solve problems presented in these courses, including the ability to visualize the abstract concepts presented to them. Exams and homework assignments are among the standard tools used to assess students' performance and comprehension of course material. Student ability is determined by the quality of the written answers and by how well they document the process used to solve a problem. However, they provide only limited opportunities to reveal the viewing strategies used that may give additional insight into how students initially approach the given problem.

In the present study, we use a within-subject experimental design to investigate the relationship between spatial visualization abilities of students and how students solve specific problems in the area of mechanics of materials. We employ a non-invasive eye-tracker (Tobii X-60) to record participants' eye movements during each problem solving task. According to the eye-mind hypothesis, people look at what they are thinking about. Participants were asked to solve several problems in the field of mechanics of materials, and the diagram of each problem was shown on a computer display. The data collected included: participants' fixation time, fixation counts, and scan paths of the critical areas of each diagram. The data were correlated with students' performance on Purdue Spatial Visualization Test and solid mechanics problems.

The preliminary results show differences in the eye gaze data of high and low performance participants and provide insight into students' problem-solving strategies and difficulties, offering instructors new facts to adopt appropriate teaching methods for different students.

**Key words:** engineering problem-solving, eye gaze data, visual attention

## I. Introduction

Solving complex problems is an important symbol of human intelligence and has always fascinated researchers. Though mental problem-solving studies originated in psychology, today some of their methods and techniques are applied and developed in other areas such as mathematics<sup>[1]</sup>, computer science<sup>[2]</sup>, engineering<sup>[3]</sup>, and medicine<sup>[4]</sup>. Although these researchers come from different backgrounds, the questions of common interest are how exactly people solve problems and how their performance may be improved.

According to Budny's research on freshman performance in engineering courses at Purdue University<sup>[5]</sup>, over a span of fifteen years (1978-1993) approximately 36% of the entering

engineering students failed to complete the freshman requirements and thus did not transfer into one of the professional schools of engineering. Interviews with these students indicated that the main reason for leaving engineering was difficulty with calculus, chemistry, or physics. Details are not discussed as to why students found these topics difficult.

Traditional assessment tools, such as homework, projects, and exams have been developed to test students' grasp of and ability to apply new concepts<sup>[6]</sup>. However, they do not always reveal the viewing strategies used by students during problem solving. It is difficult for teachers and evaluators to determine whether a student's unsatisfactory performance is the result of misunderstanding of concepts or weakness in spatial thinking, or other factors. Many instructors suggest oral tests (*i.e.*, asking students to introduce their approach to solving problems verbally) as the best way to examine whether students truly understand the critical concepts and methods presented in class. However, time constraints are typically prohibitive so universities only rarely administer oral tests.

Fortunately, eye-tracking technology enables researchers to observe people's visual attention during problem solving. Eye-tracking research is based on the eye-mind hypothesis which states that people look at what they are thinking about<sup>[7]</sup>. It assumes that people fixate on a specific area of a problem diagram longer when they encounter difficulties or are confused. Utilizing eye-tracking technology allows to discover the visual attention patterns of students' while solving engineering problems, and to investigate the significant factors impacting their performance, including spatial thinking ability, and their understanding of specific concepts. Once such patterns of visual attention are discovered, they can be leveraged to detect the most challenging concepts, and may enable instructors to provide more targeted help to students.

In this paper, the visual attention during solving engineering problems (here, solid mechanics problems) of 18 undergraduate students was evaluated using eye tracking. The students were asked to solve six spatial thinking problems and five solid mechanics problems displayed on a computer screen. The results suggested that the pattern of eye gaze data differed between students who performed at different levels of success. High performers tended to fixate less frequently at critical areas of the problem diagram when solving spatial thinking problems. This indicates they quickly assimilated the visual information provided in order to do the rotations for the given PSVT problem. They also fixated more on the critical areas when solving solid mechanics problems, indicating they understood the area of the diagram that would be most informative in solving the problem. An opposite trend was observed in low performers. This study indicated that the eye gaze data could be used as a diagnostic tool to help instructors determine their students' grasp of concept and improve their teaching methods accordingly.

In the remainder of this paper Section 2 provides background on problem-solving, visual perception and eye tracking methods and proposes five hypotheses. The experimental methods and results are presented in Sections 3 and 4, respectively. Detailed explanations for the study

results are given in Section 5, and Section 6 provides a conclusion and outlook in terms of future work.

## II. Background

This paper draws on literature that considers how people solve visual search problems, how graphical factors influence visual perception, and the related eye tracking technology.

### 2.1 Research on Problem-Solving and the Role of Visual Search

We distinguish between well-defined and ill-defined problems<sup>[8]</sup>. Well-defined problems have specific goals and clearly defined solution procedures (*i.e.*, closed form), while ill-defined problems do not (*i.e.*, open-ended such as design problems). When students approach typical engineering textbook problems, such as solid mechanics which is mainly concerned with the relationships between external effect (forces and moments) and internal stresses and strains of solids<sup>[9]</sup>, they first use the section method and draw the free-body diagrams to obtain the force distribution at the point of concern. Then they need to apply the proper equations related to the mechanics of materials to determine the magnitude and direction of normal or shearing stresses, such as Equations (1) and (2).

$$\text{Torsion: } \tau_{max} = \frac{Tr}{J} \quad (1)$$

$$\text{Bending: } \sigma_x = -\frac{My}{I} \quad (2)$$

where  $\sigma_x$  = normal axial stress,  $\tau$  = shearing stress due to torque,  $T$  = torque,  $r$  = radius,  $J$  = polar moment of inertia of circular cross section,  $M$  = bending moment

Such problems are well-defined and focus on the ability to understand and interpret mechanics diagrams. Individuals solving such problems must be able to determine the important visual clues in the diagram during the problem solving task. Thus visual search plays an important role here.

Visual search is a perceptual task involving an active scan of the visual environment for a particular object or feature among other objects or features<sup>[10]</sup>. With time, it is possible to develop visual search abilities such that decisions can be made quickly and efficiently, *e.g.*, how workers can identify the gender of day-old chicks in less than 1 second<sup>[11]</sup>.

Insight problems provide another example of the role of visual search during problem solving tasks. An insight problem is a problem that requires the examinee to shift his or her perception and view the problem in a novel way in order to identify the solution. Grant *et al.*<sup>[12]</sup> studied how eye movements reveal critical aspects in solving the tumor-and-lasers radiation problem, a classical insight problem developed by Duncker in 1945<sup>[13]</sup>. In one experiment they found that particular fixation patterns correlate with success in solving this particular insight problem. In a second experiment, they found that perceptually highlighting the critical diagram component,

identified in the first experiment, significantly increased the frequency of correct solutions. The authors suggested that environmentally controlled perceptual properties can guide attention and eye movements in ways that assist in developing problem-solving insights that dramatically improve reasoning.

Other studies verified this pattern in other contexts, such as during the examination of chest X-ray (CXR) films <sup>[14]</sup>, in aviation <sup>[15]</sup>, during driving <sup>[16]</sup>, solving anagram problems <sup>[17]</sup>, and when identifying explosives at airports <sup>[18]</sup>. Thus, it is expected to find different visual attention patterns in people that solve engineering problems with different levels of success.

## **2.2 Research on Visual Perception**

Engineers encounter complex drawings, from mechanical parts to electrical circuits. Most mechanical engineers are taught drafting <sup>[19]</sup>, and it is no exaggeration to say that the use of diagrams is ubiquitous in engineering. For engineering students it is important to grasp the skills of perceiving and interpreting diagrams well. In modern psychology, *Gestalt* theory was developed to explain people's visual perception patterns and assisting the design of interactive media <sup>[20][21][22]</sup>. Some of the most important of *Gestalt* visual laws are figure/ground, proximity, closure, similarity, and continuation (for more details, see Graham's work <sup>[23]</sup>).

With respect to engineering problems, a variety of factors can impact people's visual perception, one of which is the graphical representation mode of the problem (3D or 2D, colorful or chromatic, prototype or sketching, etc.) <sup>[24-37]</sup>. Nada <sup>[38]</sup> found that the level of detail and realism strongly correlated with the assessment of the accuracy of representations and also was identified as a criterion for the overall credibility. Cölln <sup>[39]</sup> suggested that a modestly better performance can be achieved with 3D-CAD visualization compared to a conventional engineering drawing. Thus, it is of interest to determine whether different representation modes of problem diagrams (2D or 3D) have an influence on students' performance when solving engineering problems and whether this influence may be used to help with students' learning.

## **2.3 Research on Problem Solving by Eye Tracking**

Recent advances in eye tracking, specifically the availability of cheap, faster, more accurate and more user-friendly eye trackers, enable researchers in psychology and other areas to apply this technology for visual attention research <sup>[40][41]</sup>, including attention neuroscience <sup>[42]</sup>, reading <sup>[43]</sup>, visual inspection <sup>[44]</sup>, studying worked-out physics problems <sup>[46]</sup>, and product design <sup>[47][48]</sup>.

The main metrics used in eye-tracking include: (1) fixations: eye movements that stabilize the retina over a stationary object of interest; (2) fixation time: a measure of the duration of the fixation; and (3) scan paths: connections between consecutive fixations <sup>[50]</sup>. The location and duration of fixations is directly related to the locus and difficulty of cognitive processing <sup>[51]</sup>. Thus eye movements may provide insight into what visual information is being processed currently and how difficult this information is to process, which may serve as an additional

measure for learning and problem solving processes <sup>[52]</sup>. An increasing number of researchers are starting to apply eye tracking technology in studying people's problem solving process; *e.g.*, Madsen's study of visual attention in physics problem solving <sup>[52]</sup>.

Madsen showed that when solving physics problems, both top-down and bottom-up processes are involved. The top-down processes are internal and determined by one's prior knowledge and goals. The bottom-up processes are external and determined by features of the visual stimuli such as color and luminance contrast. Madsen's study assumed that eye movements reflect a person's moment-to-moment cognitive processes, providing a window into one's thinking. In a previous study, the way correct and incorrect solvers viewed relevant and novice-like elements in a physics problem diagram were compared and it was determined that correct solvers spent more time attending to relevant areas, while incorrect solvers spent more time looking at novice-like areas.

In the second study, Madsen overlaid these problems with dynamic visual cues to help students redirect their attention and found that in some cases, these visual cues improved problem-solving performance and influenced visual attention. In a third study, Madsen manipulated the perceptual salience of the diagram elements via changes in luminance contrast. These changes did not influence participants' answers or visual attention. Instead, similar to the first study, the time spent looking in various areas of the diagram was related to the correctness of an answer. These results suggest that top-down processes dominate when solving physics problems.

Madsen's work verified that there are specific visual attention patterns for correct solvers and incorrect solvers in their problem-solving processes. It would be helpful to improve students' performance by manipulating problem diagrams, *e.g.*, by providing visual cues. Thus it is expected that specific visual attention trends can be identified in students who solve engineering problems with different levels of success.

## **2.4 Summary and Research Hypotheses**

Existing literature has discovered fundamental aspects of visual search problem-solving and graphical representation mode's influence on visual perception. The literature has also emphasized the value of eye gaze data in obtaining visual attention patterns during the problem-solving process and in facilitating people's solving performance. However, there is limited work evaluating what critical factors impact students' solving engineering problems and how the eye gaze data reveal students' visual attention pattern in such process. This paper seeks to bridge that gap in research investigating the following hypotheses:

H1a: Students' spatial visualization skills positively correlate with their performance when solving solid mechanics problems.

H1b: Different visual attention patterns exist in high and average performers when solving spatial thinking problems.

H2a: Graphical representation modes (answers in 2D/3D) can impact students' problem-solving process, and students are expected to perform better when solving engineering problems with 2D answers than those with 3D answers.

H2b: Different visual attention patterns exist in students solving solid mechanics problems with 2D answers compared to those with 3D answers.

H3: Different visual attention patterns exist in low and high performers when solving solid mechanics problems.

### **III. Methods**

#### **3.1 Design of Experiment**

This study consists of a computer-based survey that presented six spatial thinking problems and five solid mechanics problems to participants. Instructions and practice problems were provided before the participants began to solve real problems. The spatial thinking problems were selected from the Revised Purdue Spatial Visualization Test: Rotation (initially developed by Guay, 1976<sup>[53]</sup> and modified by Yoon, 2011<sup>[54]</sup>, hereinafter named PSVT for short). PVST is considered one of the best measures of an individual's spatial ability<sup>[55]</sup>. The PSVT consists of a total of 30 questions that must be completed in 20 minutes to completely assess students' spatial visualization abilities. In order to keep the study time to a reasonable length and minimize fatigue and its impact on eye-tracking data<sup>[56][57]</sup>, we conducted a pilot study to identify an appropriate subset of the PSVT. The results from the pilot study led to the use of six representative problems with different levels of difficulty, where difficulty was determined by the length of time people took to complete the questions. The use of six questions provided sufficient information for our study. A sample PSVT problem is shown in Figure 1. The participants were asked to study how the object in the top line of the question was rotated and then determine how the object shown in the middle line will appear when rotated in exactly the same way. Finally, they had to select the representation that looks like the object rotated in the correct position from five alternative drawings (A, B, C, D or E) given. In this sample problem, A, B, D and E are wrong; only C looks like the object rotated according to the given rotation.

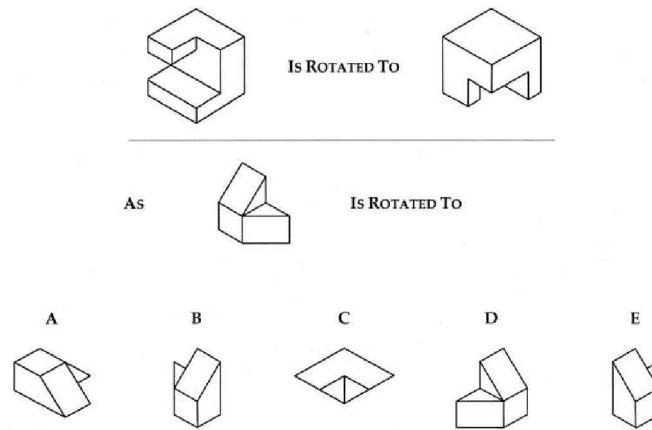

Figure 1. A sample PSVT problem

The solid mechanics problems were taken from Beer's textbook *Mechanics of Materials* <sup>[58]</sup>. To assess the impact of the graphical representation mode on students' problem solving, the answers to two of the five solid mechanics problems were presented in a 2-dimensional way and the other three in a 3-dimensional way (hereinafter named as 2D problems and 3D problems for short). A sample solid mechanics problem is shown in Figure 2. The participants were required to identify the state of stress at the element in point H in order to determine whether shearing and/or normal stresses existed in all six faces of the element and their directions. Since a vertical force P along the negative y-axis was applied at the end of the cantilever ABE, an equivalent bending moment and torque were applied at point H. Therefore, a tensile normal stress existed in the left and right faces of the element and a shearing stress existed in the front, rear, left and right faces of the element. The correct answer was C.

In this problem, participants first had to apply the concepts of combined loads introduced in class to identify the state of stress at point H and then use their spatial thinking ability to project the stresses into the corresponding faces of the 3D element, with which they were likely to be unfamiliar because students encounter 2D situations more often at undergraduate level.

Figure 3 illustrates the case of a solid mechanics problem with 2D answers for control purposes. Participant had to identify the state of stress at point K. Here, the answer was D.



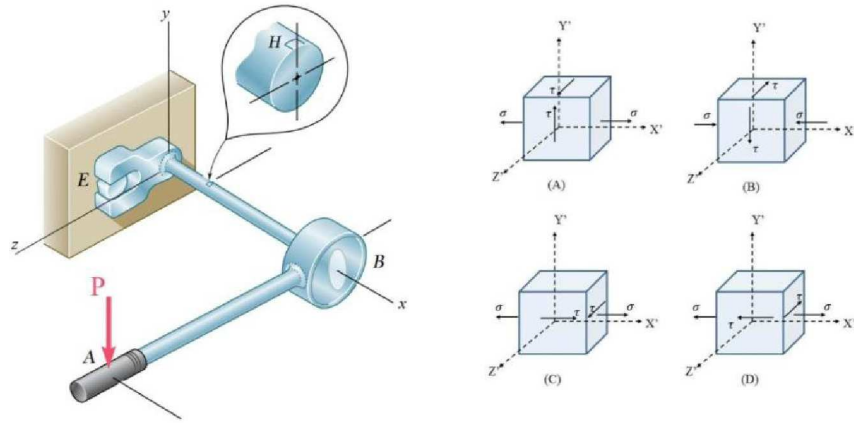

Figure 2. A sample problem of solid mechanics with 3D answers

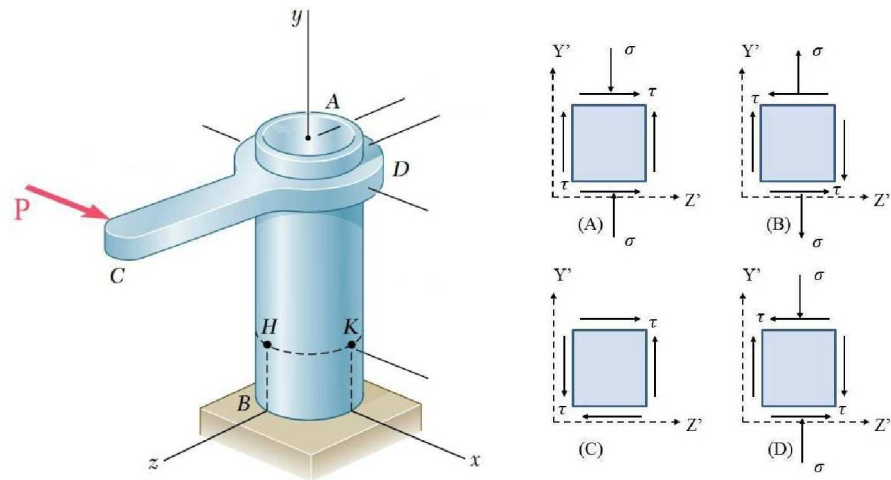

Figure 3. A sample problem of solid mechanics with 2D answers

### 3.2 Participants

A total of 18 undergraduate students from the Mechanical Engineering department of a large Midwest university participated in this preliminary study, ranging in age between 18 and 24 years. All were taking or had already taken the related engineering courses, such as statics and mechanics of materials. Their demographic information and knowledge background is shown in Table 1 and Table 2.

Table 1. Demographic information of participants

	Participants	Gender		Grade	
		Male	Female	Junior	Senior
Number	18	14	4	11	7
Percentage	100%	77.8%	22.2%	61.1%	38.9%

Table 2. Knowledge background of participants

	Participants	Currently enrolled in related course*		Completed related course*	
		Self-reported as “doing well in class”	Self-reported as “doing average in class”	Received an A or A- in course	Received a B or B- in course
Number	18	5	5	3	5
Percentage	100%	27.8%	27.8%	16.6%	27.8%

\*: The course was *Mechanics of Materials* or similar

Participants were undergraduate students who were recruited by email. They also had to meet the inclusion criteria suggested by Pernice and Nielsen<sup>[59]</sup> to satisfy the experimental conditions of eye tracking research:

- Have normal to corrected vision (contact lenses and glasses are okay except for bifocals, trifocals, layered lenses or regression lenses).
- Do not have glaucoma, cataracts, eye implants, or permanently dilated pupils.
- Can read a computer screen and the Web without difficulty.
- Do not need a screen reader, screen magnifier or other assistive technology to use the computer and the Web.

### 3.3 Experimental Procedure and Data Collection

After passing pre-screening, qualified participants were introduced to the purpose and procedures of the study by the experimenter. Then participants were required to sit in front of a computer display and adjust their sitting positions to ensure the successful calibration of the eye-tracker (Tobii<sup>®</sup> X-60). If the calibration result was poor, participants had to do a recalibration. If the calibration result was good or above, participants would see a welcome screen with a brief introduction and several practice problems before solving the real problems. They were asked to solve six PSVT problems and five solid mechanics problems without pen or paper, and selected the answers from multiple choices by clicking the mouse. This process typically took 15 to 30 minutes.

To investigate the effect of solving problems using a computer only, 11 participants were asked to solve two additional similar solid mechanics problems with pen and paper so that the results could be compared. After that, all participants had to take a survey about their demographic information and educational background. Lastly, they received \$10 as compensation for attending this study.

The data collected in the experiment included participants’ performance in solving PSVT and solid mechanics problems and their eye gaze data, including fixation time, fixation counts, revisits, and scanpath in specific Areas of Interest (AOIs) during the problem-solving process

and their responses in the survey. In this study, a fixation was defined as a focus on a specific area for more than 100 milliseconds. Revisits were defined as the number of fixations at a same point.

## IV. Results

### 4.1 Participants' Performance Solving PSVT Problems

The participant earned one point if he or she selected the correct answer for each of the six PSVT problems. Otherwise, zero points were assigned. The overall PSVT performance of each participant was calculated as shown in Equation (3):

$$P = \frac{\text{all points earned}}{6} \times 100\% \quad (3)$$

The average PSVT performance in this study was  $69.44\% \pm 25.08\%$ , and the comparison of different participants' performance is presented in Figure 4.

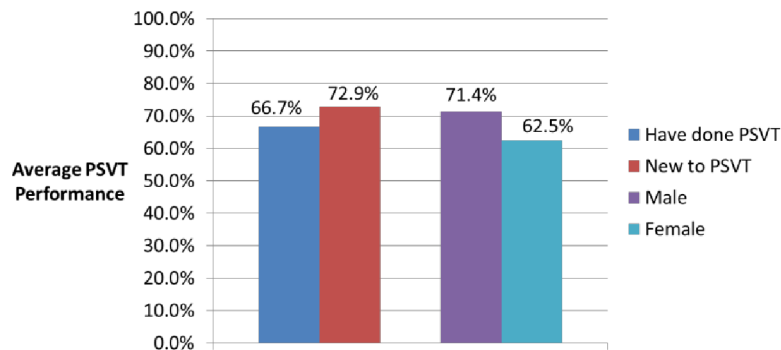

Figure 4. Comparison of the PSVT performance of different participants

Among the 18 participants, 10 had previously been exposed to PSVT and the other eight had not. The average PSVT performance of participants previously exposed to PSVT was  $66.7\% \pm 28.3\%$  and that of those new to PSVT was  $72.9\% \pm 21.7\%$ . The data shows that students who were new to PSVT performed better, though the difference was not significant ( $p = 0.698$  based on the Welch two sample t-test). However, there was a significant difference ( $p=0.007$ ) in the average time spent solving each PSVT problem for participants who were previously exposed to PSVT ( $M=24.6$  s,  $SD=4.1$  s) and those who were not ( $M=39.8$  s,  $SD=13.1$  s). Although students new to PSVT spent more time in the solving process, further analysis showed there was no correlation between performance and time spent on PSVT problems (Pearson correlation coefficient  $r(16) = -0.006$ ,  $p = 0.981$ ).

Within the current sample, there was no significant difference ( $p=0.314$ ) in average PSVT performance between male participants ( $M=71.4\%$ ,  $SD=24\%$ ), and female participants ( $M=62.5\%$ ,  $SD=31.5\%$ ). In this pilot study, there were significantly fewer female participants than

male participants. A significant difference in performance depending on gender may occur in a study with a larger sample size, as Yoon's previous research<sup>[54]</sup> suggests.

#### 4.2 Participants' Performance Solving Solid Mechanics Problems

Analogously, participants earned one point if they selected the right answer for each of the five solid mechanics problems. If the participant selected the answer with correct stress directions but failed to correctly project them into the 3D space, they received a half point. Otherwise, zero points were given. For example, in the problem presented in Figure 2, participants received one point if they selected C, half point if they selected A, and zero points if other options were chosen. Then the overall solid mechanics problem performance of each participant was calculated using Equation (3) with a denominator of 5. The performance for 3D and 2D problems was evaluated analogously. Participants' average solid mechanics problem performance was  $43.3\% \pm 18.8\%$ , and their average performance on 3D and 2D problems was  $41.7\% \pm 19.2\%$  and  $45.8\% \pm 31.2\%$  respectively. The t-test showed that this difference was not significant ( $p=0.317$ ), which can be intuitively observed by the paired profiles for 3D and 2D problem performance in Figure 5. In this plot, a line is drawn for each participant connecting his/her 3D problem performance to 2D problem performance. The mean performances are connected by a bold line. Widely varying slopes indicate the lack of correlation and high between-subject variability. Also, Fisher's Exact Test ( $p=0.121$ ) showed that there is no evidence of an association between the 3D and 2D tests.

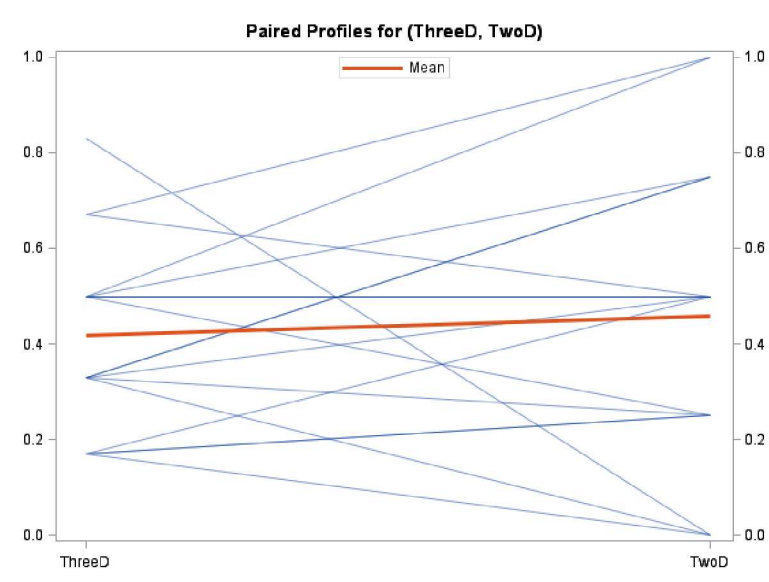

Figure 5. Paired profiles for the performance of 3D and 2D problems

The scatter plot of participants' PSVT performance and solid mechanics problem performance is shown in Figure 6.

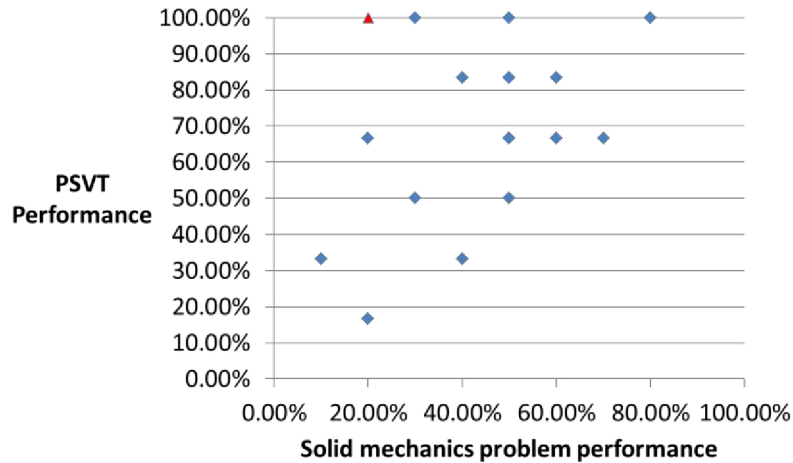

Figure 6. Scatter plot of participants' PSVT performance and solid mechanics problem performance

The Pearson correlation coefficient between participants' PSVT performance and solid mechanics problem performance is  $r(16) = 0.395$  with  $p = 0.104$ . However, one participant's data was an anomaly in the study (represented by a triangle in Fig. 6). Each set of options included one answer choice in which no logical reasoning could be used to arrive at that answer. This participant happened to choose these options indicating that perhaps he was not familiar with this topic or happened to be choosing his answers at random. When excluded, the Pearson correlation is  $r(15) = 0.541$  with  $p = 0.025$ , which indicates that these two performances were correlated positively.

### 4.3 Participants' Eye Gaze Data during Problem-Solving

#### 4.3.1 Eye Gaze Data during Solving PSVT Problems

The heat maps of the visual stimuli in Figure 7(a) show how all viewers' attention was distributed during their problem-solving process. For example, participants mostly focused on the first item in the top line, indicating a high level of emphasis on studying the rotation pattern of the object, see Figure 7(a). It also shows participants' eye movements in this area. Thus, seven AOIs were created for all six PSVT problems as shown in Figure 7 (b). Based on the heat maps shown, AOI (A) was selected for further study because it shows the most concentrated area of eye-gaze activity.

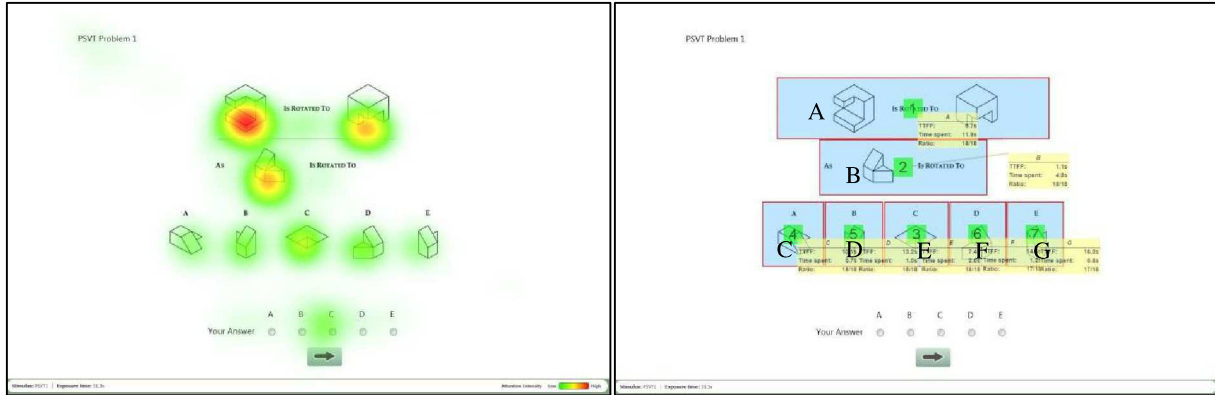

Figure 7. (a) Heat map of the PSVT problem 1; (b) major AOIs of PSVT problem 1

Figure 8 presents a comparison of key eye-tracking metrics in AOI (A) between high performers and the average level performance for all six PSVT problems. The data and p-values (based on Welch two sample t-test to detect their statistical differences) are given in Table 3.

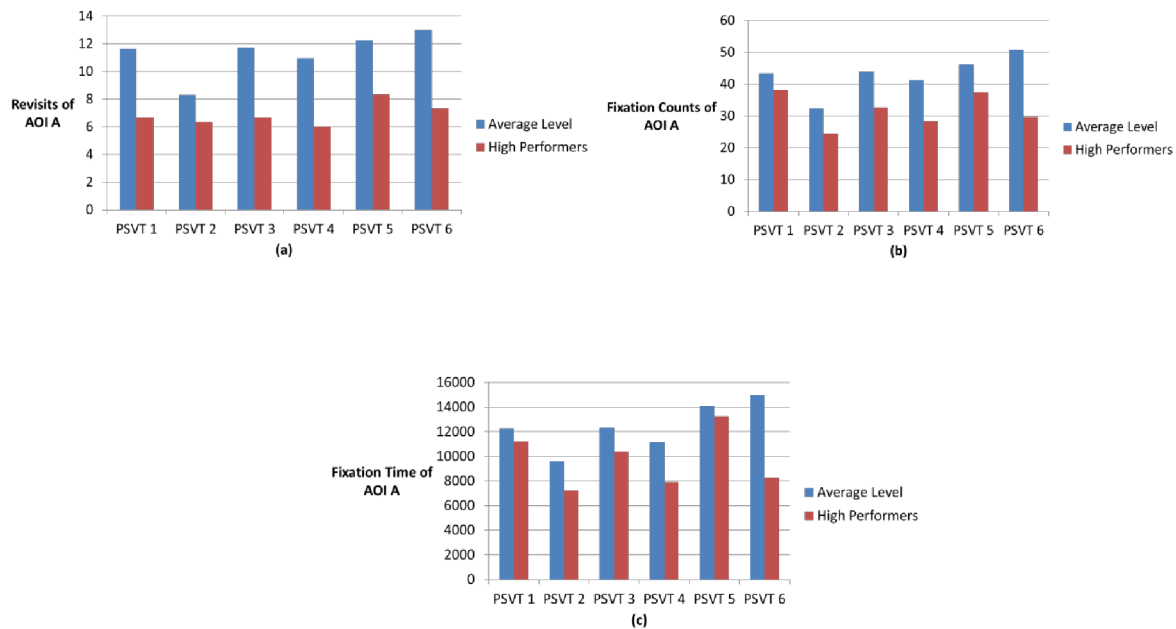

Figure 8. Comparison of (a) revisits, (b) fixation counts, and (c) fixation time between high performers and the average level in AOI (A) for PSVT problems.

Table 3. Comparison of key eye-tracking metrics between high performers and the average level in AOI (A) for PSVT problems.

	Revisits		Fixation Counts		Fixation Time (ms)	
	Average	High	Average	High	Average	High
PSVT 1	11.6	6.6	43.3	38	12270.7	11185
PSVT 2	8.2	6.3	32.4	24.3	9601.05	7219.33
PSVT 3	11.7	6.6	44	32.6	12325.1	10389.3

PSVT 4	10.9	6	41.1	28.3	11134	7898.6
PSVT 5	12.2	8.3	46.2	37.3	14077.5	13254.3
PSVT 6	13	7.3	50.7	29.6	15003.9	8271
p-value	<0.0001		0.004		0.028	

Apparently, high PSVT performers spent less time and fixated less frequently on the critical area A.

### 4.3.2 Eye Gaze Data during Solving Solid Mechanics Problems

Similarly, the heat map of the stimuli of a solid mechanics problem indicated that participants fixated more often on the point whose state of stress needed to be determined. Thus, AOI(C) was determined as the most essential area for further study (see Figure 9).

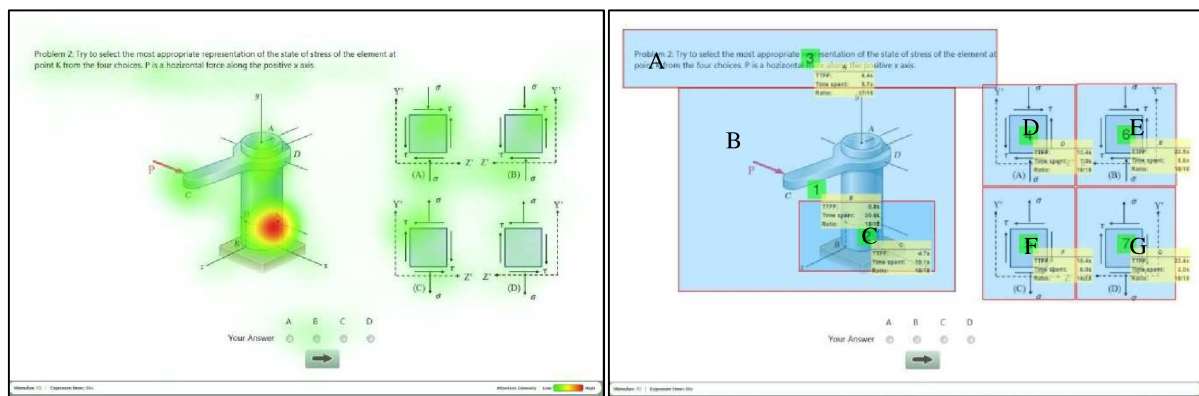

Figure 9. (a) Heat map of solid mechanics problem 2; (b) major AOIs of solid mechanics problem 2

Figure 10 presents a comparison of key eye-tracking metrics between low performers and high performers in AOI (C) for all five solid mechanics problems. The data and the p-values are presented in Table 4.

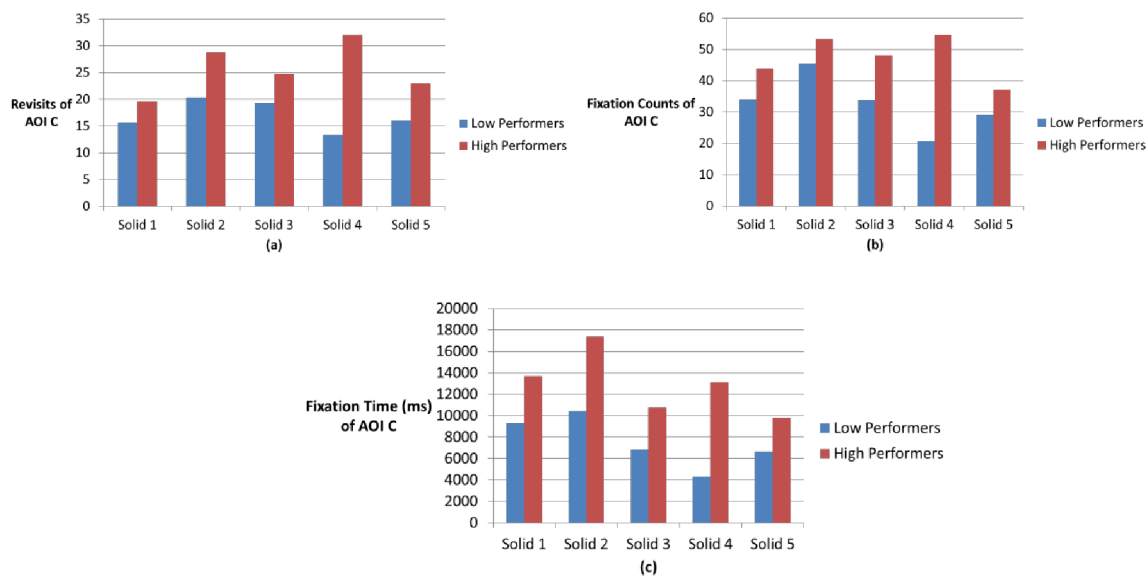

Figure 10. Comparison of (a) revisits, (b) fixation counts, and (c) fixation time between low performers and high performers in AOI (C) for solid mechanics problems.

Table 4. Comparison of key eye-tracking metrics between low performers and high performers in AOI (C) for solid mechanics problems.

	Revisits		Fixation Counts		Fixation Time (ms)	
	Low	High	Low	High	Low	High
Solid 1	15.6	19.5	34	43.7	9314.3	13683.7
Solid 2	20.3	28.7	45.3	53.2	10430	17392.0
Solid 3	19.3	24.7	33.6	48	6850.6	10744.0
Solid 4	13.3	32	20.6	54.5	4273.3	13111.2
Solid 5	16	23	29	37	6638.6	9801.2
p-value	0.007		0.012		0.008	

The data show that participants who performed well solving solid mechanics problems tended to focus on the critical area more frequently and longer than low performers. However, the differences between participants' performance on 3D and 2D solid mechanics were not significant ( $p>0.05$ ), as shown in Figure 11.

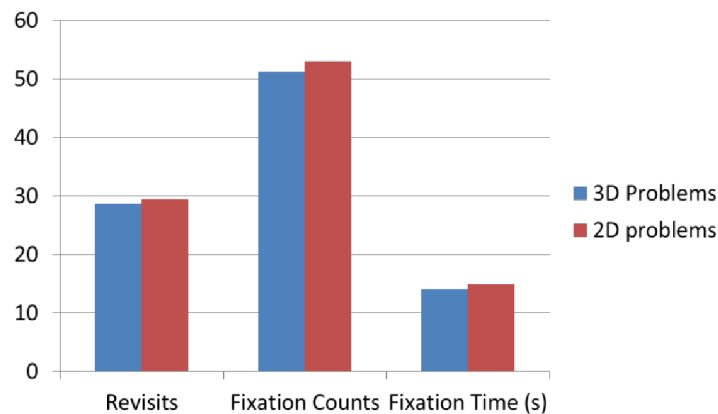

Figure 11. Comparison of revisits, fixation counts and fixation time between low performers and high performers in AOI (C) for solid mechanics problems.

### 4.3.3 Scan Path Data

In addition to the common metrics used in eye-tracking, scan path analysis enables researchers to investigate whether viewers follow a similar sequence of visual search. In this analysis scan paths are compared pair wise to determine how similar they are. This study applied ScanMatch<sup>[60]</sup>, which is an algorithm that compares two scan paths at a time and computes a score representing their similarity in space and time. It is based on the Needleman-Wunsch algorithm used to compare DNA sequences. The Scanmatch score ranges between [0, 1], and a larger score means higher similarity between two scan paths. All possible comparisons between two participants' scan paths were investigated, and the highest and lowest ScanMatch scores for solving each PSVT problem and solid mechanics problem are listed in Table 5 and 6,



respectively. Notice that in the second row of Table 5, subject 8 and subject 10 both earned 1 point in solving problem PSVT 1, and the ScanMatch score of comparing their scan path is 0.5918, which is the highest among all comparisons.

Table 5. Highest and lowest Scanmatch scores for solving PSVT problems

Problem	Highest Scanmath score	ID of participants compared	Corresponding points earned in each problem for each respective participant	Lowest Scanmath score	ID of participants compared	Corresponding points earned in each problem for each respective participant
PSVT 1	0.5918	8 vs. 10	1-1	0.0877	9 vs. 13	0-1
PSVT 2	0.6710	14 vs. 16	1-1	0.1126	13 vs. 15	1-1
PSVT 3	0.7438	8 vs. 9	1-1	0.1911	3 vs. 8	1-1
PSVT 4	0.6901	1 vs. 16	1-1	0.2111	5 vs. 9	0-1
PSVT 5	0.6330	2 vs. 16	1-1	0.2045	3 vs. 9	0-1
PSVT 6	0.6515	8 vs. 18	0-0	0.1262	12 vs. 17	0-1

Table 6. Highest and lowest Scanmatch scores for solving solid mechanics problems

Problem	Highest Scanmath score	ID of participants compared	Corresponding points earned in each problem for each respective participant	Lowest Scanmath score	ID of participants compared	Corresponding points earned in each problem for each respective participant
Solid 1	0.6079	7 vs. 14	0.5-0.5	0.2572	11 vs. 12	1-0
Solid 2	0.5444	11 vs. 14	1-0.5	0.2080	10 vs. 18	0-0
Solid 3	0.5150	1 vs. 3	0-0	0.1148	16 vs. 18	0-0
Solid 4	0.4708	14 vs. 17	0.5-1	0.2134	10 vs. 18	0-1
Solid 5	0.5467	1 vs. 7	0-0	0.1092	6 vs. 16	0-0

As shown in Table 5, participants with the highest Scanmatch score performed similarly in solving PSVT problems, although it is difficult to determine whether they performed well or poorly based on the recorded scores. In contrast, participants with the lowest Scanmatch scores performed more diversely in solving PSVT problems. However, this phenomenon is not as pronounced with respect to participants' performance in solving solid mechanics problems, as shown in Table 6.

#### 4.4 Participants' Performance Solving Additional Solid Mechanics Problems

As previously mentioned, eleven of the participants were required to solve two similar 3D solid mechanics problems using pen and paper after they completed the computer-based survey.

This was done to determine whether the use of a computer had an effect on the performance. The results show that there was no significant difference ( $p=0.201$ ) between participants' average performance solving solid mechanics problems with paper and pen ( $54.55\% \pm 27.0\%$ ) and 3D problems on the computer-based survey ( $45.45\% \pm 22.5\%$ ).

## V. Discussion

Spatial thinking ability plays an important role in solving solid mechanics problems in this study. Participants had to apply the right-hand rule to identify the directions of shearing stress caused by torsion and visualize the free body diagrams in their minds without using paper and pen. Thus it was expected that high performers in PSVT problems would perform better solving solid mechanics problems, which was verified by the Pearson correlation test ( $p=0.025$ ). Therefore, hypothesis H1a is accepted. Furthermore, the Area of Interest analysis indicated that high performers spent less time and fixated less frequently on the critical area of the visual stimulus in PSVT (see Figure 8 and Table 3). The differences revealed by eye-tracking metrics, including revisits, fixation counts, and fixation time, between high PSVT performers and average level performers were statistically significant. This result implies that high PSVT performers understood and memorized the rotation pattern in each PSVT problem faster, and they performed better in spatial thinking which verifies hypothesis H1b.

At the undergraduate level, students are more familiar with the 2D state of stress analysis when learning mechanics of materials. The normal procedures for solving solid mechanics problems include drawing free body diagrams, determining various types of loading (tension or compression, torsion and bending), and drawing the 2D state of stress analysis diagram. In the present study, participants had to follow the same procedure and project the 2D state of stress into a 3D element. Thus it was expected for participants to perform differently in 2D and 3D problems because of the different demands on spatial thinking ability; here, students were expected to perform better solving 2D problems. However, although the participants' performance solving 2D problems was slightly better than their performance solving 3D problems ( $45.8\%$  versus  $41.7\%$ , see Figure 5), the  $p$ -value  $0.317$  suggested that the difference was not significant. The eye gaze data (see Figure 11) also indicated that participants behaved similarly when viewing the critical area of the stimulus in the solid mechanics problems. Thus the hypotheses H2a and H2b are rejected. It is reasonable that H2b is rejected, because students followed their usual solving strategies for 2D problems when dealing with 3D problems. These results were further supported by the scan path data listed in Table 4. Participants applied similar visual search paths when solving PSVT and solid mechanics problems. The main reason for the results that led to the rejection of hypothesis H2a is that most of the junior students were either unskilled in applying the correct equations or forgot how to apply these equations to determine the state of stress (*i.e.*, they are currently taking the course in mechanics of materials). They often made mistakes when drawing the 2D state of stress analysis diagram in both 2D and 3D problems.

It is interesting that high performers focused on the critical area more frequently and longer than low performers (see Figure 10 and Table 4) when solving solid mechanics problems. The differences in number of revisits, fixation counts and fixation time between high performers and low performers were statistically significant. Therefore, hypothesis H3 is accepted. This is consistent with the findings in Section 2.1, in particular with Madsen's work. Low performers allocated less visual attention to the critical areas when solving solid mechanics problems mainly because they were unskilled in applying the correct equations and concepts as mentioned above. In the present study, junior students' average performance when solving solid mechanics problems was  $38.9\% \pm 16.9\%$ , while senior students' average performance was  $51.3\% \pm 18.9$  ( $p=0.087$ ). According to our survey, 37.5% of senior students participating in our study had taken other courses related to mechanics of materials, such as machine design. Therefore, they were better skilled in applying the equations in solid mechanics. Unskilled solvers were more likely to guess the answer rather than obtaining the answer by following the formal procedures, which would have required them to focus more on the critical areas of the problem diagram.

The comparison of participants' performance when solving solid mechanics problems (see Section 4.3) indicates that participants performed slightly better solving solid mechanics problems when they were provided paper and pen, though this difference was not significant ( $p=0.201$ ). We assume that a larger sample may provide more convincing evidence for this improvement.

## **VI. Conclusion**

The present study verified that students' spatial visualization skills correlate with their performance when solving solid mechanics problems correctly and that there are different eye gaze patterns between high and average performers when solving spatial thinking problems. High performers spent less time and fixated less frequently on the critical area of the visual stimulus in PSVT, which implies that they understood and memorized the rotation patterns provided in the problem diagrams faster. However, the way the four answers to each question (*i.e.*, options A-D) are represented (2D or 3D) did not seem to impact participants' performance when solving solid mechanics problems and/or their eye gaze patterns. This result was mainly attributed to the fact that participants actually applied the same procedures when solving 2D or 3D solid mechanics problems, but were lacking conceptual understanding. Thus the significant differences in their performance and eye movements between solving 2D and 3D solid mechanics problems fail to express this explicitly. In addition, different eye gaze patterns recognized in low and high performers when solving solid mechanics problems. High performers focused at the critical areas of the problem diagram more frequently and longer than low performers. This difference was mainly attributed to knowledge of specific equations and concepts in solid mechanics, and senior students performed better than junior students.

This investigation showed that eye gaze data has the potential to serve as a diagnostic tool to discern how low and high performers express different visual attention patterns during problem

solving tasks. This was examined in the context of solving PSVT and solid mechanics problems, allowing for correlations between participants' spatial thinking ability and performance in specific concepts of solid mechanics. These results have the potential to help instructors choose more adaptive teaching strategies for different students. However, a larger sample size will help to make these findings more conclusive. Another potential limitation of this study is the fact that the incentive for participation was not performance-based and therefore participants may not have put forth their best effort. These issues will be addressed during the remainder of this study. Future work will involve exploring whether students' problem solving performance will be improved by enhancing their spatial thinking abilities or understanding of key concepts in mechanics. In addition, we are planning on extending this research to other areas of application, such as engineering design or other disciplines and recruiting participants at various levels of academia (*i.e.* graduate students, instructors, and faculty members) to examine the impact of experience/expertise. Although eye-trackers are becoming more accessible and affordable, they are not widely used and it requires trained personnel to manage every stage of the study. In addition, running eye-tracking studies can be time intensive. Therefore, future work will develop possible models based on existing eye gaze data, to offer prediction models of eye movement trends.

### **Acknowledgments**

Sincere gratitude is extended to Dr. So Yoon Yoon, who provided the official duplicate of the PSVT:R, members of the REID Lab and Professor Chuck Krousgrill, who offered valuable suggestions to this research.

### **References**

- [1] Schoenfeld, Alan H. *Mathematical problem solving*. New York: Academic press, 1985.
- [2] Kay, Dana S. Computer interaction: Debugging the problems. *Complex problem solving: Principles and mechanisms*, 1991: 317-340.
- [3] Hegarty, Mary. Knowledge and processes in mechanical problem solving. *Complex problem solving: Principles and mechanisms*, 1991: 253-285.
- [4] Elstein, Arthur S. and Schwarz, V. Evidence base of clinical diagnosis: Clinical problem solving and diagnostic decision making: selective review of the cognitive literature. *British Medical Journal*, 2002. 324(7339) : 729-732.
- [5] Budny, Dan, LeBold, William and Bjedov, Goranka. Assessment of the Impact of Freshman Engineering

- Courses\*. *Journal of Engineering Education*, 1998. 87(4): 405-411.
- [6] Richards-Babb, Michelle, Drelick, Janice, Henry, Zachary, Robertson-Honecker, Jennifer. Online Homework, Help or Hindrance? What Students Think and How They Perform. *Journal of College Science Teaching*, 2011. 40(4): 81-93.
- [7] Just, Marcel Adam and Carpenter, Patricia A. Eye fixations and cognitive processes. *Cognitive Psychology*, 1976. 8(4): 441-480.
- [8] Schacter, Daniel L., Gilbert, Daniel, Wegner, Daniel M., Hood, Bruce. *Psychology*, Second Edition. New York: Worth Publishers, 2009: 376
- [9] Ugural, Ansel C. and Fenster, Saul K. *Advanced strength and applied elasticity*. Pearson Education, 2003.
- [10] Donnelly, N., Cave, K.R., Welland, M., Menneer, T. Breast screening, chicken sexing and the search for oil: challenges for visual cognition. Geological Society, London, Special Publications, 2006. 254(1): 43-55.
- [11] Biederman, Irving, and Shiffrar, Margaret M. Sexing day-old chicks: A case study and expert systems analysis of a difficult perceptual-learning task. *Journal of Experimental Psychology: Learning, Memory, and Cognition*, 1987. 13(4): 640.
- [12] Grant, Elizabeth R. and Spivey, Michael J. Eye movements and problem solving guiding attention guides thought. *Psychological Science*, 2003. 14(5): 462-466.
- [13] Duncker, Karl and Lees, Lynne S. On problem-solving. *Psychological Monographs* , 1945: 58(5).
- [14] Vitak, Sarah A., Ingram, John E., Duchowski, Anrew T., Ellis, Steven, Gramopadhye, Anand K. Gaze-augmented think-aloud as an aid to learning. *Proceedings of the 2012 ACM annual conference on Human Factors in Computing Systems*. ACM, 2012: 2991-3000.
- [15] Ottati, W. Leigh, Hickox, Joseph C. and Richter, Jeff. Eye scan patterns of experienced and novice pilots during visual flight rules (VFR) navigation. *Proceedings of the Human Factors and Ergonomics Society Annual Meeting*. SAGE Publications, 1999: 43(1).
- [16] Underwood, Geoffrey, Chapman, Peter, Brocklehurst, Neil, Underwood, Jean, Crundall, David. Visual attention while driving: sequences of eye fixations made by experienced and novice drivers. *Ergonomics*, 2003. 46(6): 629-646.
- [17] Ellis, Jessica J., Glaholt, Mackenzie G. and Reingold, Eyal M. Eye movements reveal solution knowledge prior to insight. *Consciousness and Cognition*, 2011. 20(3): 768-776.
- [18] Schuster, David, Rivera, Javier, Sellers, Brittany C., Fiore, Stephen M., Jentsch, Florian. Perceptual training for visual search. *Ergonomics*, 2013. 56(7): 1-15.
- [19] Ullman, David G., Wood, Stephen and Craig, David. The importance of drawing in the mechanical design process. *Computers & graphics*, 1990. 14(2): 263-274.
- [20] Chang, Dempsey, Dooley, Laurence and Tuovinen, Juhani E. Gestalt theory in visual screen design: a new look at an old subject. *Proceedings of the Seventh world conference on computers in education: Australian topics-Volume 8*. Australian Computer Society, Inc., 2002.
- [21] Mercedes M. Fisher and Smith-Gratto, Karen. Gestalt theory: a foundation for instructional screen design. *Journal of Educational Technology Systems*, 1998. 27(4): 361-371.
- [22] Moore, Patrick and Fitz, Chad. Using Gestalt theory to teach document design and graphics. *Technical communication quarterly*, 1993. 2(4): 389-410.

- [23] Graham, Lisa. Gestalt theory in interactive media design. *Journal of Humanities & Social Sciences*, 2008: 2(s1).
- [24] Artacho-Ramírez, M. A., Diego-Mas, J. A. and Alcaide-Marzal, J. Influence of the mode of graphical representation on the perception of product aesthetic and emotional features: An exploratory study. *International Journal of Industrial Ergonomics*, 2008. 38(11): 942-952.
- [25] Garmendia, Mikel, Guisasola, Jenaro and Sierra, Egoitz. First-year engineering students' difficulties in visualization and drawing tasks. *European Journal of Engineering Education*, 2007. 32(3): 315-323.
- [26] Golick, Douglas A., Heng-Moss, Tiffany M., Steckelberg, Allen E., Brooks, David W., Higley, Leon G.. Using Web-Based Key Character and Classification Instruction for Teaching Undergraduate Students Insect Identification. *Journal of Science Education and Technology*, 2012: 1-13.
- [27] Juergen Sauer and Sonderegger, Andreas. The influence of prototype fidelity and aesthetics of design in usability tests: effects on user behavior, subjective evaluation and emotion. *Applied Ergonomics*, 2009. 40(4): 670-677.
- [28] Maries, Alexandru and Singh, Chandralekha. A good diagram is valuable despite the choice of a mathematical approach to problem solving, 2013.
- [29] Menezes, Alexandre and Lawson, Bryan. How designers perceive sketches. *Design Studies*, 2006. 27(5): 571-585.
- [30] Purcell, A. T. and Gero, John S. Drawings and the design process: A review of protocol studies in design and other disciplines and related research in cognitive psychology. *Design studies*, 1998. 19(4): 389-430.
- [31] Reffold, C. N. Teaching and learning computer-aided engineering drawing. *International Journal of Engineering Education*, 1998. 14(4): 276-281.
- [32] Sagan, E. and Yang, M. C. Perception and Interpretation: Points of focus in Design Sketches. *ASME 2012 International Design Engineering Technical Conferences*, 2012: 763-772.
- [33] Sauer, Jürgen, Seibel, Katrin and Rüttinger, Bruno The influence of user expertise and prototype fidelity in usability tests. *Applied Ergonomics*, 2010. 41(1): 130-140.
- [34] Tovey, Michael. Drawing and CAD in industrial design. *Design Studies*, 1989. 10(1): 24-39.
- [35] Vergara, Margarita, Mondragon, Salvador, Sancho-Bru, Joaquin L., Company, Pedro, Agost, Maria-Jesus. Perception of products by progressive multisensory integration. A study on hammers. *Applied Ergonomics*, 2011. 42(5): 652-664.
- [36] Yang, Maria C. A study of prototypes, design activity, and design outcome. *Design Studies*, 2005. 26(6): 649-669.
- [37] Yang, Maria C. and Cham, Jorge G. An analysis of sketching skill and its role in early stage engineering design. *Journal of Mechanical Design*, 2007. 129(5): 476.
- [38] Bates-Brkljac, Nada. Assessing perceived credibility of traditional and computer generated architectural representations. *Design Studies*, 2009. 30(4): 415-437.
- [39] Cölln, Martin C., Kusch, Kerstin, Helmert, Jens R., Kohler, Petra, Velichkovsky, Boris M., Pannasch, Sebastian. Comparing two types of engineering visualizations: Task-related manipulations matter. *Applied Ergonomics*, 2012. 43(1): 48-56.

- [40] Duchowski, Andrew T. Eye tracking methodology: Theory and practice. Vol. 373. Springer, 2007.
- [41] Duchowski, Andrew T. A breadth-first survey of eye-tracking applications. *Behavior Research Methods, Instruments, & Computers*, 2002. 34(4): 455-470.
- [42] Posner, Michael I., Snyder, Charles R. and Davidson, Brian J. Attention and the detection of signals. *Journal of experimental psychology*, 1980. General 109(2): 160-174.
- [43] Rayner, Keith. Eye movements in reading and information processing: 20 years of research. *Psychological Bulletin*, 1998. 124(3): 372-422.
- [44] Schoonard, James W. and Gould, John D. Field of view and target uncertainty in visual search and inspection. *Human Factors: The Journal of the Human Factors and Ergonomics Society*, 1973. 15(1): 33-42.
- [45] Rayner, Keith, Rotello, Caren M., Stewart, Anrew J., Keir, Jessica, Duffy, Susan A. Integrating text and pictorial information: eye movements when looking at print advertisements. *Journal of Experimental Psychology: Applied*, 2001. 7(3): 219-226.
- [46] Smith, Adam D., Mestre, Jose P. and Ross, Brian H. Eye-gaze patterns as students study worked-out examples in mechanics. *Physical Review Special Topics-Physics Education Research*, 2010. 6(2): 020118.
- [47] Du, P. and MacDonald, E. Eye-Tracking Data Predicts Importance of Product Features and Saliency of Size Change. *ASME 2013 International Design Engineering Technical Conference*, Portland, Oregon, August 4-7, 2013.
- [48] Reid, T., MacDonald, E., and Du, P. Impact of Product Design Representation on Customer Judgment. *Journal of Mechanical Design*, 2013. 135(9): 091008.
- [49] Rakoczi, Gergely, Duchowski, Andrew T., Casas-Tost, Helena, Pohl, Margit. Visual perception of international traffic signs: influence of e-learning and culture on eye movements. *Proceedings of the 2013 Conference on Eye Tracking South Africa*. ACM, 2013.
- [50] Goldberg, J. H. and Kotval, X. P. Computer Interface Evaluation Using Eye Movements: Methods and Constructs. *International Journal of Industrial Ergonomics*, 1999. 24(6): 631-645.
- [51] Loftus, Geoffrey R. and Mackworth, Norman H. Cognitive determinants of fixation location during picture viewing. *Journal of Experimental Psychology: Human Perception and Performance*, 1978. 4(4): 565.
- [52] Madsen, Adrian. Studies of Visual Attention in Physics Problem Solving. Diss. Kansas State University, 2013.
- [53] Guay, Roland. Purdue spatial visualization test. Purdue University, 1976.
- [54] Yoon, So Yoon. Psychometric Properties of the Revised Purdue Spatial Visualization Tests: Visualization of Rotations (The Revised PSVT-R). Diss. Purdue University, 2011.
- [55] Branoff, Theodore J. Spatial Visualization Measurement: A Modification of the Purdue Spatial Visualization Test-Visualization of Rotations. *Engineering Design Graphics Journal*, 2000. 64(2): 14-22.
- [56] Porter, Stephen R., Whitcomb, Michael E. and Weitzer, William H. Multiple surveys of students and survey fatigue. *New Directions for Institutional Research*, 2004. 121: 63-73.
- [57] Saito, Susumu. Does fatigue exist in a quantitative measurement of eye movements? *Ergonomics*, 1992. 35(5-6): 607-615.

- [58] Beer, F. P., Johnston, E. R. and DeWolf, J. T. *Mechanics of Materials*, 6<sup>th</sup> edition. McGraw-Hill Education, 2011.
- [59] Pernice, K. and Nielsen, J. *Eyetracking Methodology: How to Conduct and Evaluate Usability Studies Using Eyetracking*. Nielsen Norman Group Technical Report, 2009.
- [60] Cristino, F., Mathôt, S., Theeuwes, J. and Gilchrist, I. D. ScanMatch: A Novel Method for Comparing Fixation Sequences. *Behaviour Research Methods*, 2010. 42: 692-700.

**Appendix: Other solid mechanics problems tested in present study**

Problem 1: Try to select the most appropriate representation of the state of stress of the element at point P from the four choices. T is a torque.

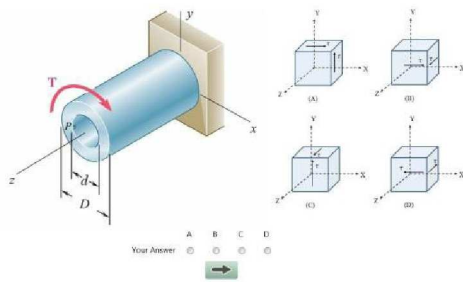

Figure A1

Problem 3: Try to select the most appropriate representation of the state of stress of the element at point H from the four choices. P is a vertical force along the negative y axis.

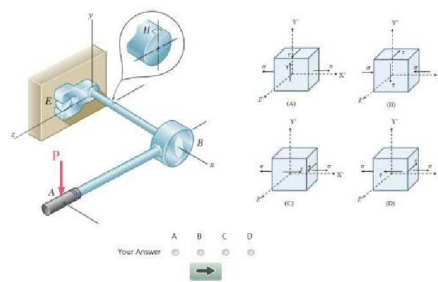

Figure A2

Problem 4: Try to select the most appropriate representation of the state of stress of the element at point K from the four choices. P is a vertical force along the positive y axis. Please neglect the shearing stress caused by bending.

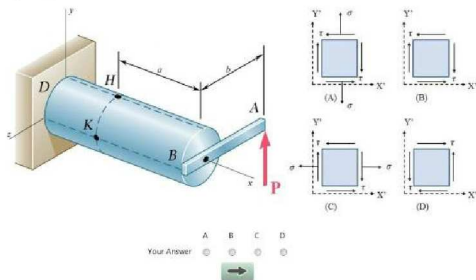

Figure A3

Problem 5: Try to select the most appropriate representation of the state of stress of the element at point a from the four choices. P is a horizontal force along the negative z axis.

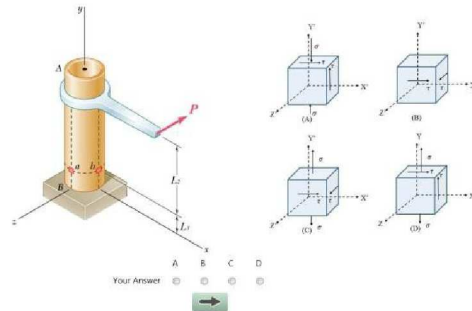

Figure A4